

S4824B and ST4824B

Available in Grid or Solid Top

COMPONENTS: 2-Shelf System

Panels: (2) 48"x24"
Legs: (6) 24"
Internal Stackers: (6)

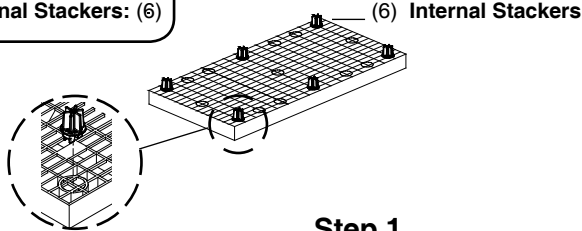

Step 1

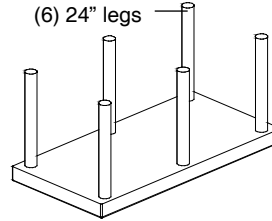

Step 2

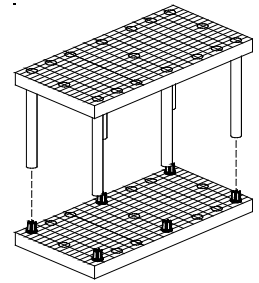

Step 3

COMPONENTS: 3-Shelf System

Panels: (3) 48"x24"
Legs: (12) 24"
Internal Stackers: (12)

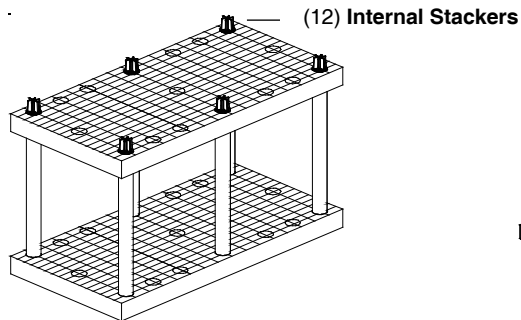

Step 1

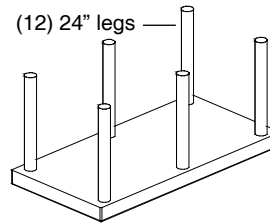

Step 2

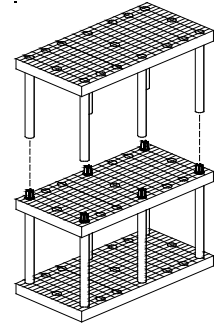

Step 3

COMPONENTS: 4-Shelf System

Panels: (4) 48"x24"
Legs: (18) 24"
Internal Stackers: (18)

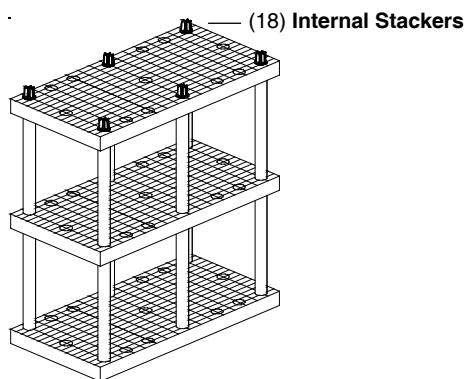

Step 1

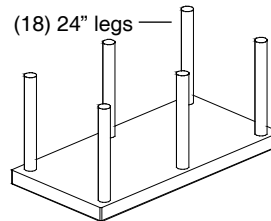

Step 2

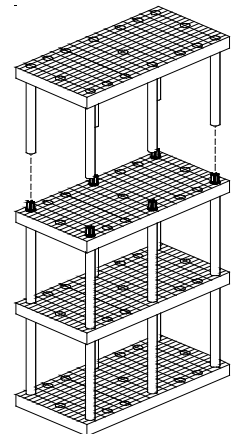

Step 3

Step 1

Lay one of the shelf panels on the floor and insert leg stackers over outside sockets as shown.

Step 2

Invert the next level panel and insert 24" posts into the sockets as shown.

Step 3

Return panel with the 24" posts to upright position. Align posts over Leg Stackers and push all the way down until leg stackers are inserted into posts. Repeat steps 1 through 3 for multi-shelf configurations.

ASSEMBLY INSTRUCTIONS

2- Options to Secure Legs to Panels

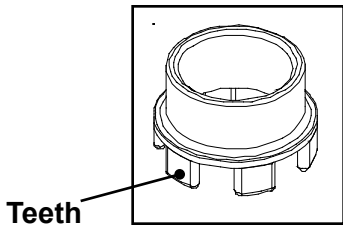

Leg Collar

How to use the Leg Collar

First, place the collar over socket aligning teeth of collar to fit through grids.

Second, Leg is inserted into the leg collar.

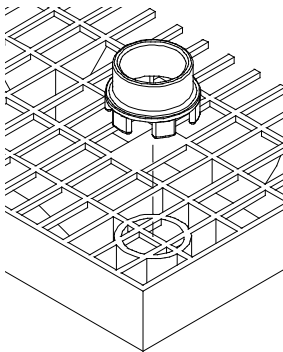

Collar Placement

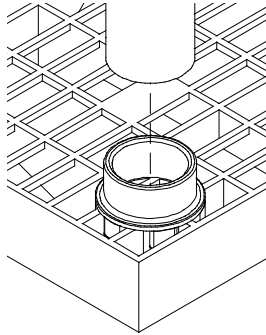

**Leg Placement on
Collar**

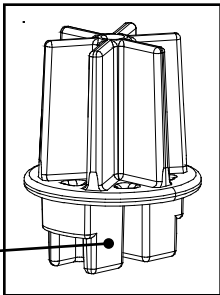

**Internal Leg
Stacker**

How to use the Internal Leg Stacker

First, Place the stacker over socket aligning the prongs with the D-shaped holes, and push down.

Second, leg is inserted over the leg stacker.

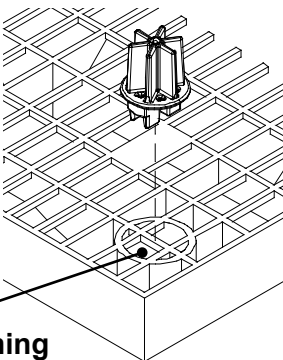

**Internal Leg Stacker
Placement**

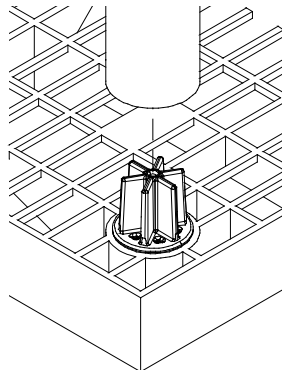

**Leg Placement on
Internal Leg Stacker**