

Adjustable DURASHELF®

ASSEMBLY INSTRUCTIONS AS3624X3 and AST3624X3

COMPONENTS:

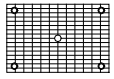

Panels: (3) 24"x36"
(4 drilled sockets)

Legs: (4) 48"
(drilled for pins)

Pins: (12)

(4) 48" Legs

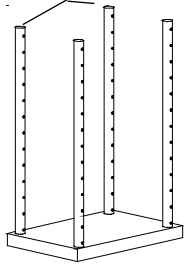

Step 1

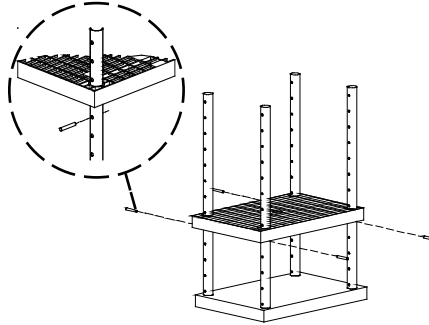

Step 2

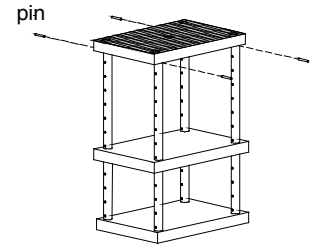

Step 3

COMPONENTS:

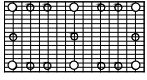

Panels: (3) 24"x48"
(6 drilled sockets)

Legs: (6) 48"
(drilled for pins)

Pins: (18)

(6) 48" Legs

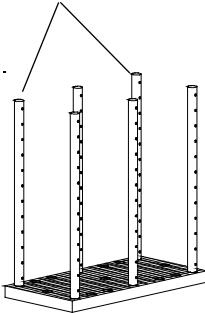

Step 1

AS4824X3 and AST4824X3

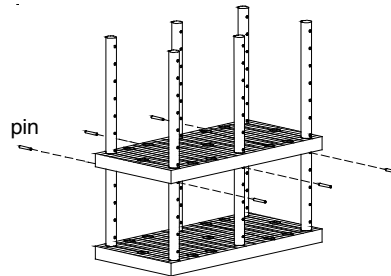

Step 2

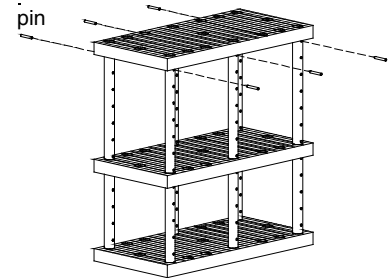

Step 3

COMPONENTS:

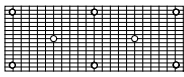

Panels: (3) 24"x66"
(6 drilled sockets)

Legs: (6) 48"
(drilled for pins)

Pins: (18)

(6) 48" Legs

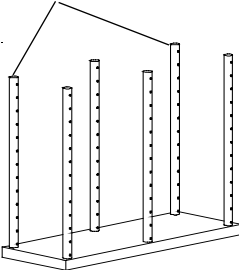

Step 1

AS6624X3 and AST6624X3

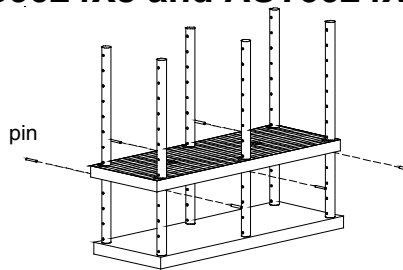

Step 2

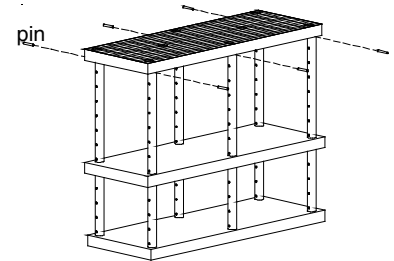

Step 3

COMPONENTS:

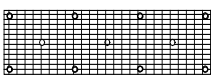

Panels: (3) 24"x96"
(8 drilled sockets)

Legs: (8) 48"
(drilled for pins)

Pins: (24)

(8) 48" Legs

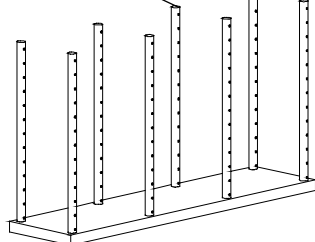

Step 1

AS9624X3 and AST9624X3

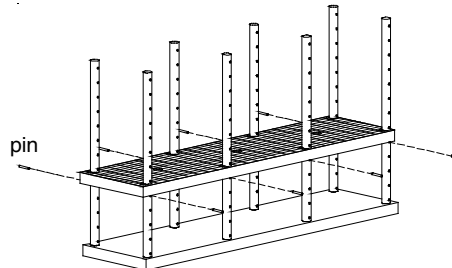

Step 2

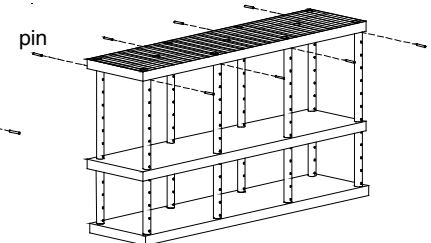

Step 3

Step 1

Lay one of the adjustable shelf panels on the floor and place **48" Legs** into the open sockets as shown.

Step 2

Insert the shelf pins into posts at desired height and slide 2nd shelf down **48" legs** until it rests squarely on pins.

Step 3

Repeat step 2 until shelf unit is complete.

Adjustable DURASHELF®

ASSEMBLY INSTRUCTIONS AS3624X4 and AST3624X4

COMPONENTS:

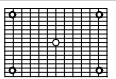

Panels: (4) 24"x36"
(4 drilled sockets)

Legs: (4) 72"
(drilled for pins)

Pins: (16)

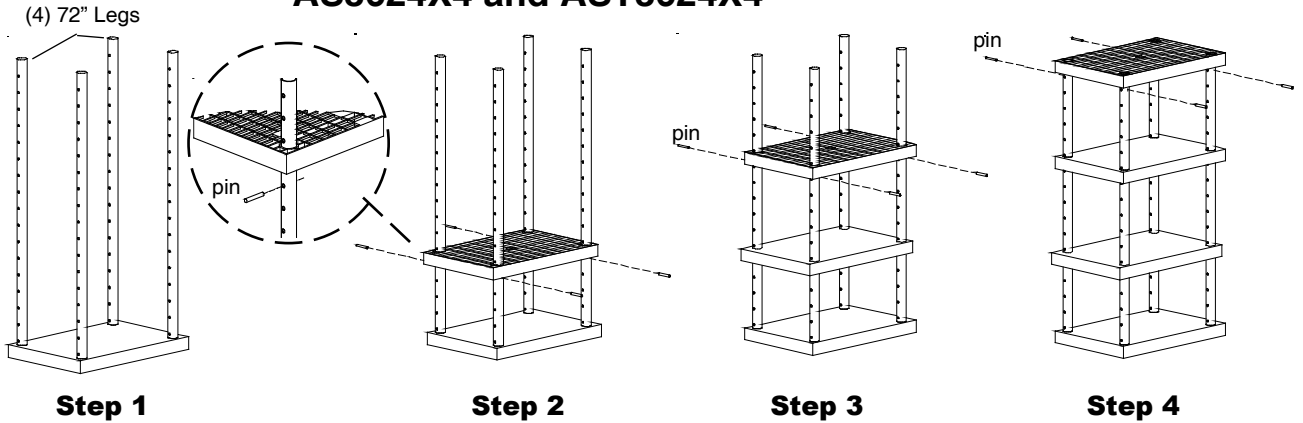

AS4824X4 and AST4824X4

COMPONENTS:

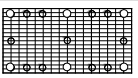

Panels: (4) 24"x48"
(6 drilled sockets)

Legs: (6) 72"
(drilled for pins)

Pins: (24)

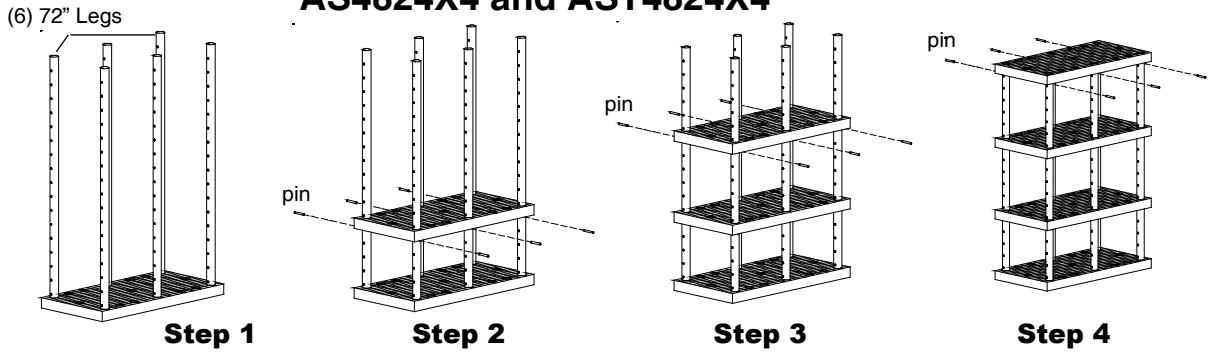

AS6624X4 and AST6624X4

COMPONENTS:

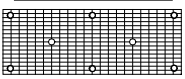

Panels: (4) 24"x66"
(6 drilled sockets)

Legs: (6) 72"
(drilled for pins)

Pins: (24)

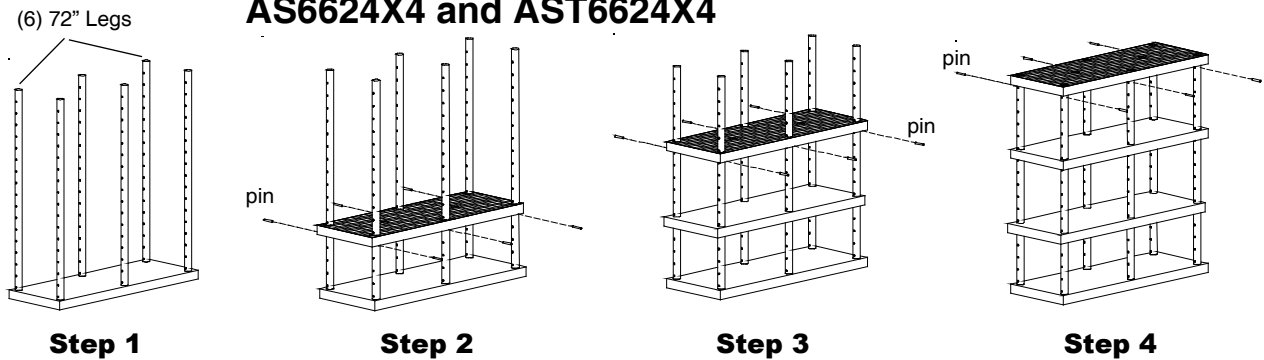

AS9624X4 and AST9624X4

COMPONENTS:

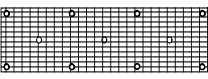

Panels: (4) 24"x96"
(8 drilled sockets)

Legs: (8) 72"
(drilled for pins)

Pins: (32)

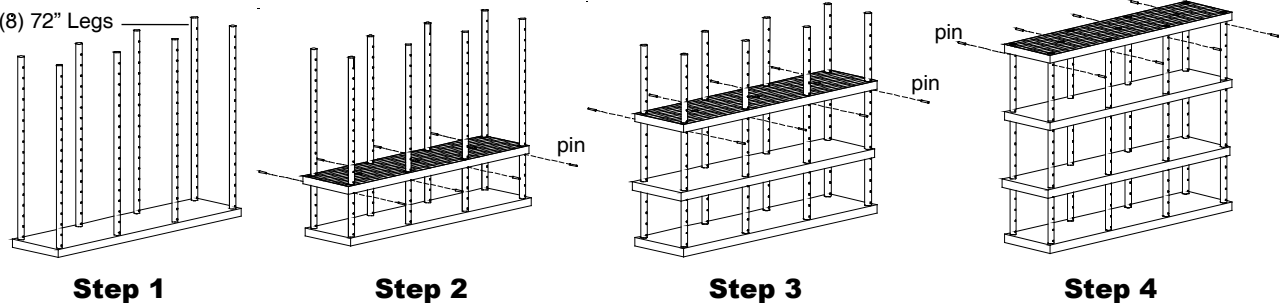

Step 1

Lay one of the adjustable shelf panels on the floor and place **72" Legs** into the open sockets as shown.

Step 2

Insert the shelf pins into posts at desired height and slide 2nd shelf down **72" legs** until it rests squarely on pins.

Step 3 & Step 4

Repeat step 2 until shelf unit is complete.